



E3 CLD Hardware Systems for Composite Doors

centor®

CONTENTS

E3 CLD – Special Design .....	1
Technical Detail .....	2
Cladding Details .....	2
Screw Hole Positions .....	3
Architectural Detail .....	4
Hardware Selection .....	8
Surelock Adjustment .....	16

# ADDRESSES THE UNIQUE REQUIREMENTS OF COMPOSITE DOORS



## E3 CLAD – SPECIAL DESIGN

Created to address the unique requirements of composite door manufacturers and fabricators, E3 CLD brings the extraordinary potential of Centor's surface-mounted folding hardware to the rapidly expanding market for aluminum-clad timber doors.

Specifically designed for clad timber door panels with hinges and carriers fastened directly to the door panel edges, E3 CLD discretely maintains the clean aesthetic appearance of exterior finishes. Modified panel gaps and frame tolerances ensure enhanced panel sealing and retain E3's versatility to optimize use of this ground-breaking technology in mixed-material applications.

Retaining each of E3's acclaimed features, E3 CLD gives specifiers and door manufacturers complete freedom in door set design; inward or outward opening, any odd or even combination of identically-sized panels, all with unparalleled performance from a super-smooth, top-hung system.

E3 Clad Specifications	
<b>max opening</b>	16000mm
<b>max panel weight</b>	115kg
<b>max panel height</b>	3600mm
<b>max panel width</b>	1200mm
<b>min panel thickness</b>	57mm
<b>max number of panels</b>	16 (8+8)

**CLADDING DETAILS**

These hinges are made for cladding with a maximum thickness of 18mm. This includes the offset from panel to cladding.

1. panel gaps – 8mm
2. offset distance – 8.8mm
3. minimum panel thickness – 57mm
4. seal recommendations – AQ33, AQ21, E4QLS, QEZ345 and AQ109
5. hinge leaf extension – 55.35mm

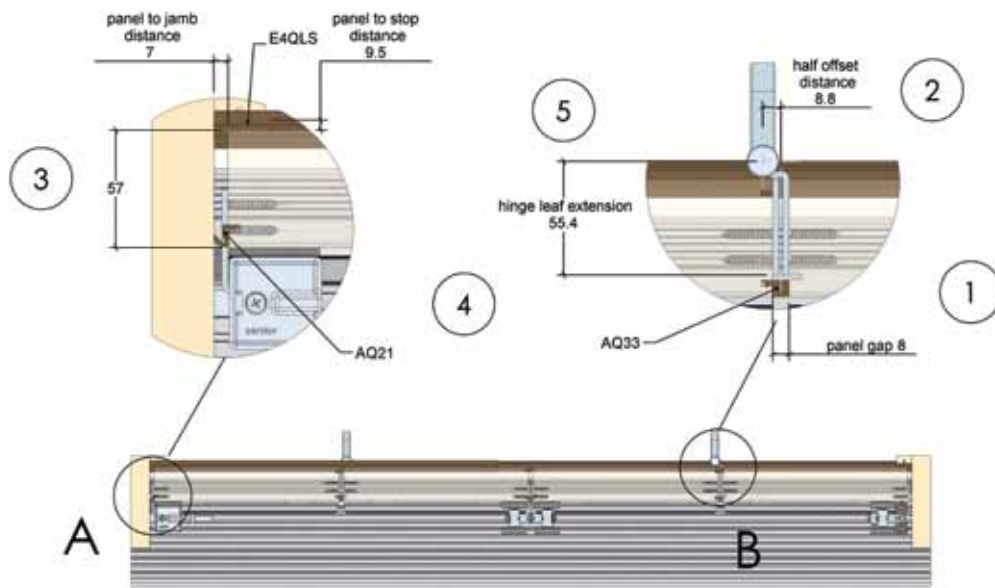

Two head sealing options are offered for the clad hinges.  
 Option A – QEZ345 in track seal provision.  
 Option B – AQ21 in timber slot next to track.

AQ109 is to be used on a meeting panel. The shape of this seal prevents the incoming door from pushing the seal out of shape.

# TECHNICAL DETAIL – SCREW HOLE POSITIONS

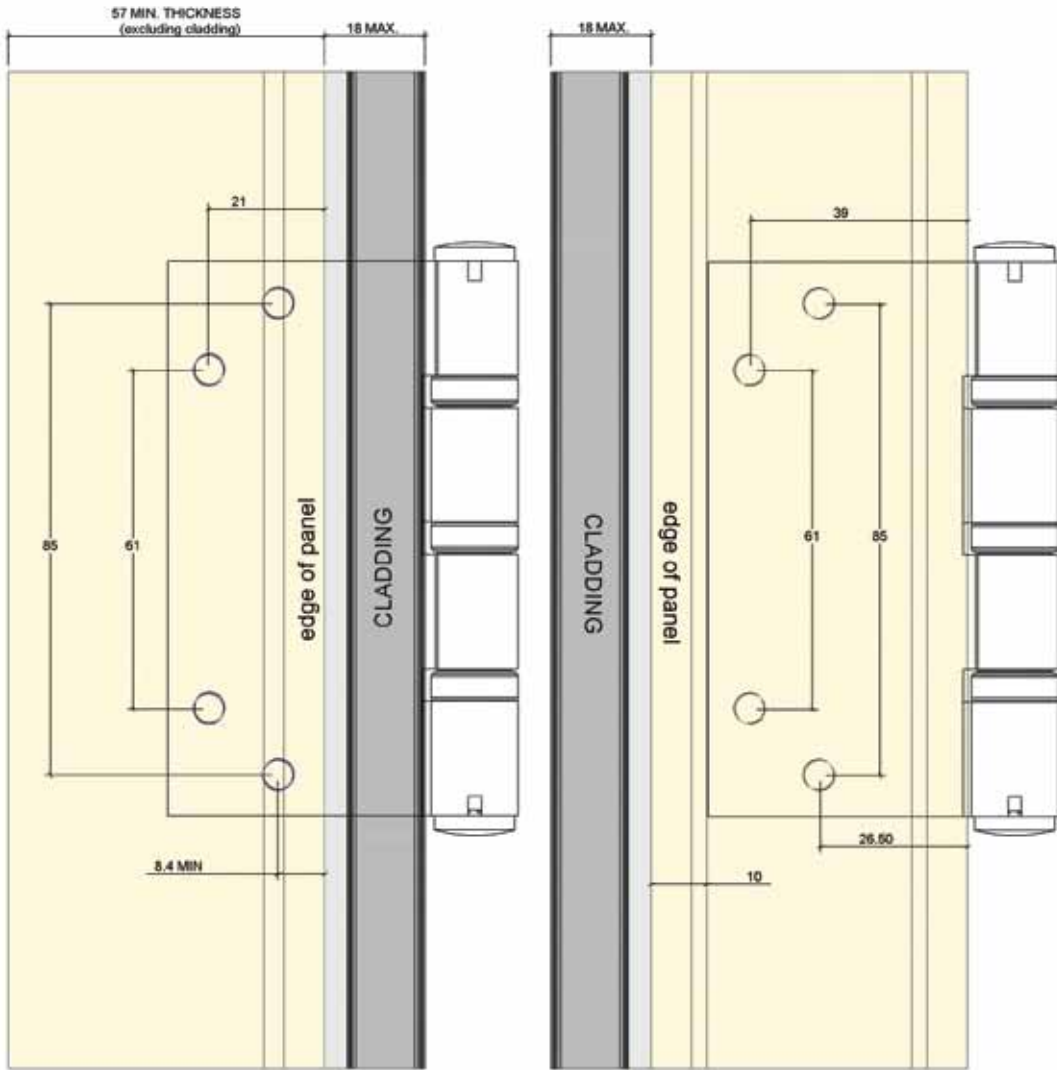

## CARRIERS AND PIVOTS

(for outward opening configurations only)

## HINGES

(for outward opening configurations only)

ARCHITECTURAL DETAIL

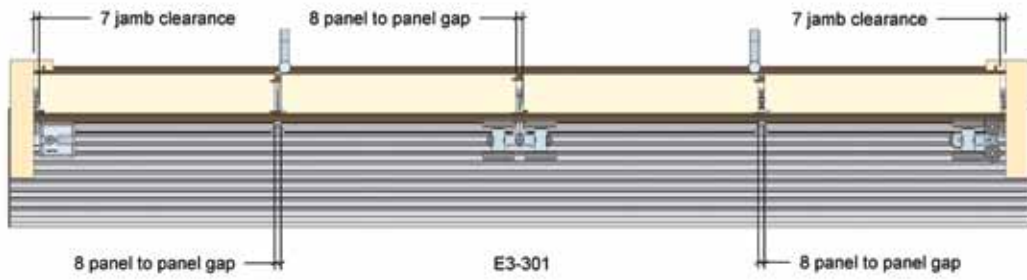

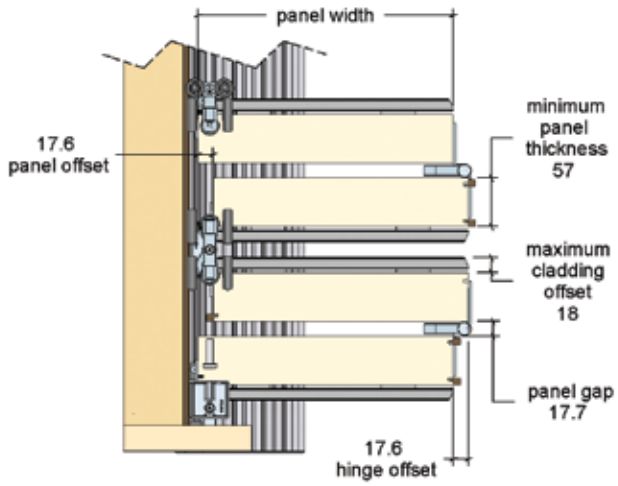

E3-303

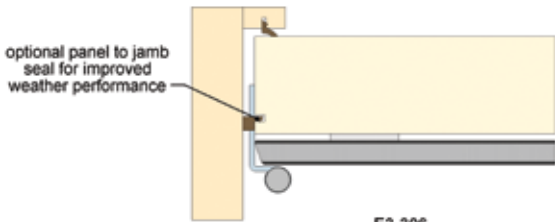

E3-306

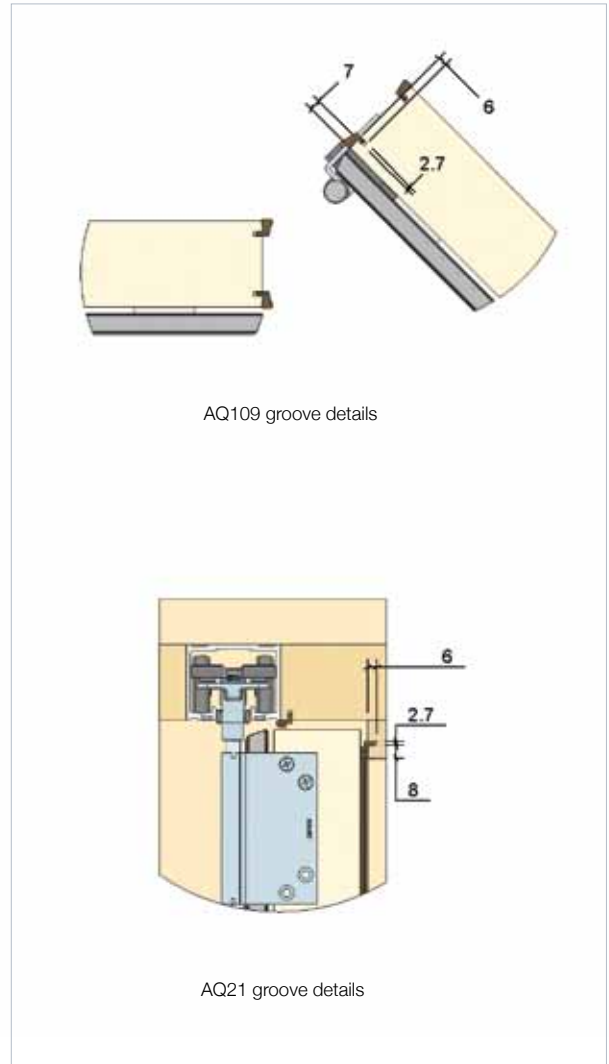

AQ109 groove details

AQ21 groove details

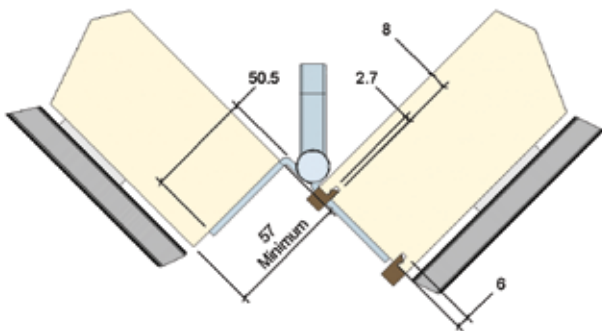

AQ33 Groove Details

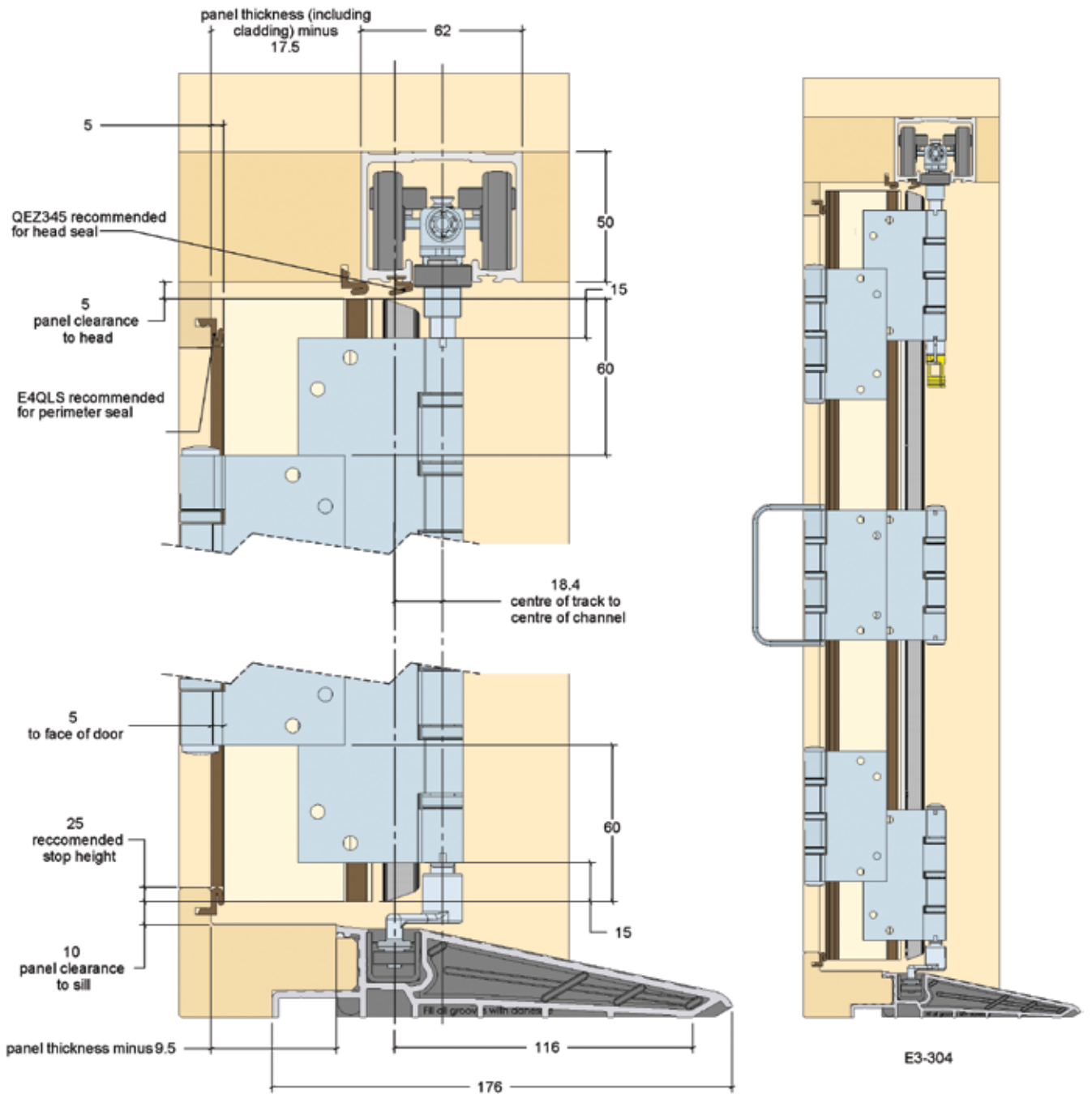



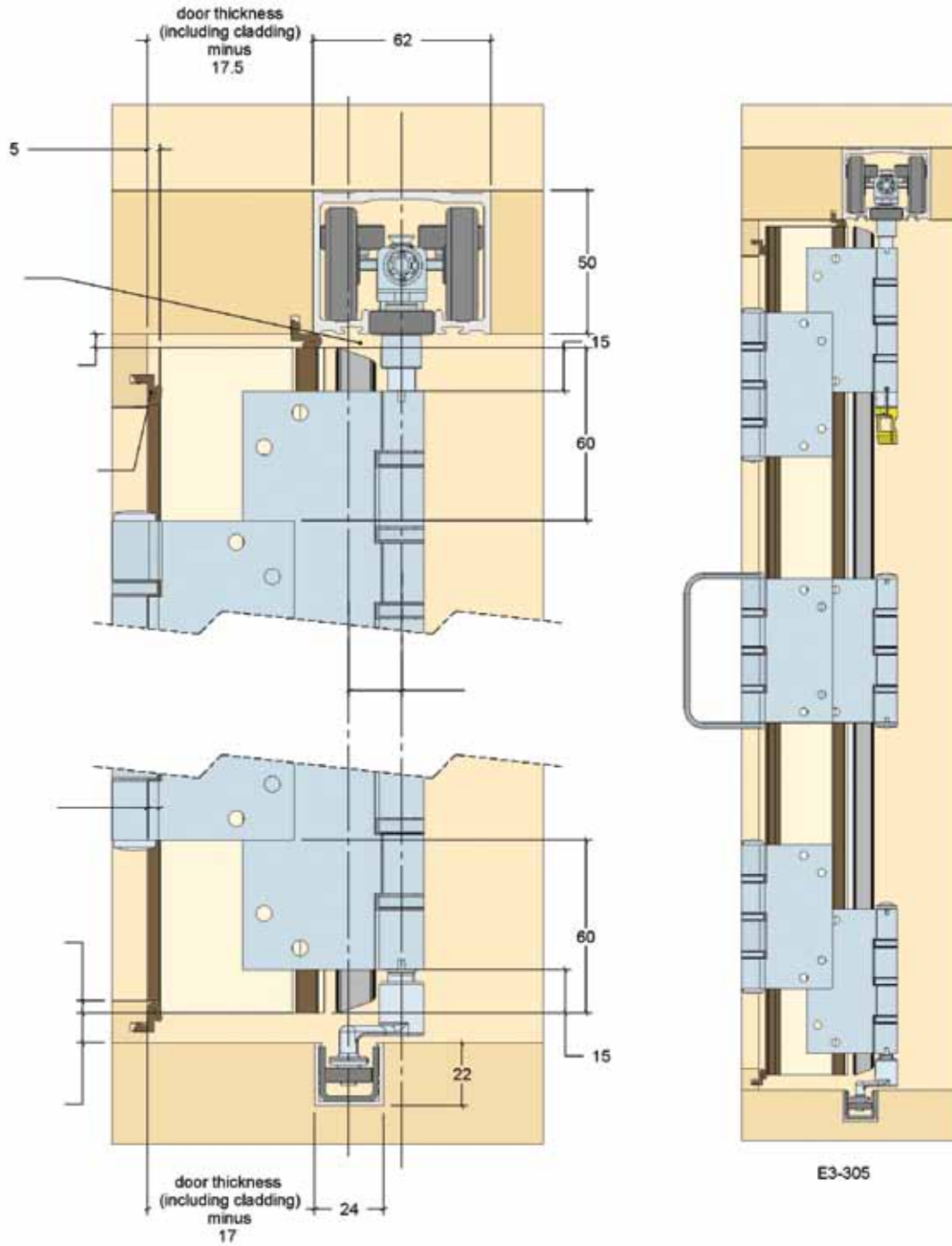

## HARDWARE SELECTION

E3 Clad is specified with 5 separate groups:

- 1 track
- 2 sill with channel
- 3 hardware
- 4 weathersealing
- 5 dropbolts



Components are required from all 5 groups to build an E3 Clad folding door system.

### TRACK

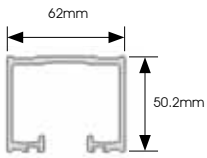
Track lengths up to 5.7m.

PART	TRACK	PRODUCT CODE	DESCRIPTION
	Aluminium track, machined	E3TAM18N	1730mm machined track, natural anodised
		E3TAM21N	2030mm machined track, natural anodised
		E3TAM24N	2330mm machined track, natural anodised
		E3TAM30N	2930mm machined track, natural anodised
		E3TAM36N	3530mm machined track, natural anodised
		E3TAM4N	4000mm machined track, natural anodised
		E3TAM42N	4130mm machined track, natural anodised
		E3TAMM57N	5700mm machined both ends track, natural anodised
		E3TAM24G	2330mm machined track, gold anodised
		E3TAM30G	2930mm machined track, gold anodised
		E3TAM4G	4000mm machined track, gold anodised
		E3TAMM57G	5700mm machined both ends track, gold anodised
		E3TAM30R	3000mm machined track, bronze anodised
		E3TAM4R	4000mm machined track, bronze anodised
		E3TAMM57R	5700mm machined both ends track, bronze anodised

### OUTWARD CONCEALED SILL

PARTS	PRODUCT CODE	DESCRIPTION
	E3CDSM36N	3600mm concealed sill, machined, natural anodised
	E3CDSM42N	4200mm concealed sill, machined, natural anodised
	E3CDSM57N	5700mm concealed sill, machined, natural anodised
	E3CDSM36R	3600mm concealed sill, machined, bronze anodised
	E3CDSM42R	4200mm concealed sill, machined, bronze anodised
	E3CDSM57R	5700mm concealed sill, machined, bronze anodised
	E3CDSER	end cap right
	E3CDSEL	end cap left





## HARDWARE SELECTION

### CHANNEL

PARTS	CHANNEL	PRODUCT CODE	DESCRIPTION
	Concealed channel 21mm, poly channel	E22FCP18	1800mm floor channel, polypropylene
		E22FCP21	2100mm floor channel, polypropylene
		E22FCP24	2400mm floor channel, polypropylene
		E22FCP30	3000mm floor channel, polypropylene
		E22FCP36	3600mm floor channel, polypropylene
		E22FCP4	4000mm floor channel, polypropylene
		E22FCP42	4200mm floor channel, polypropylene
		E22FCP57	5700mm floor channel, polypropylene
	Concealed channel 24mm, retainer	E22FCR24N	2400mm floor channel retainer, natural anodised
		E22FCR3N	3000mm floor channel retainer, natural anodised
		E22FCR36N	3600mm floor channel retainer, natural anodised
		E22FCR4N	4000mm floor channel retainer, natural anodised
		E22FCR57N	5700mm floor channel retainer, natural anodised
		E22FCR24G	2400mm floor channel retainer, gold anodised
		E22FCR3G	3000mm floor channel retainer, gold anodised
		E22FCR36G	3600mm floor channel retainer, gold anodised
		E22FCR4G	4000mm floor channel retainer, gold anodised
		E22FCR57G	5700mm floor channel retainer, gold anodised
		E22FCR3R	3000mm floor channel retainer, bronze anodised
		E22FCR4R	4000mm floor channel retainer, bronze anodised
		E22FCR57R	5700mm floor channel retainer, bronze anodised

## HARDWARE SELECTION

### WEATHERSEAL



PART	PRODUCT CODE	PART DESCRIPTION
	AQ21B	Aquamac 21 Schlegel Kerf seal, brown
	AQ21L	Aquamac 21 Schlegel Kerf seal, black
	AQ21W	Aquamac 21 Schlegel Kerf seal, white
	AQ109B	Aquamac 109 Schlegel Kerf seal, brown
	AQ109L	Aquamac 109 Schlegel Kerf seal, black
	AQ109W	Aquamac 109 Schlegel Kerf seal, white
	QEZ345B	Aquamac 345, head seal, brown
	QEZ345L	Aquamac 345, head seal, black
	QEZ345W	Aquamac 345, head seal, white
	AQ33B	Schlegel Aquamatic 33, brown
	AQ33L	Schlegel Aquamatic 33, black
	AQ33W	Schlegel Aquamatic 33, white

## HARDWARE SELECTION

### RIGHT CARRIER SET







PARTS	PARTS ON PANELS	PRODUCT CODE	DESCRIPTION
		<p>E3CLDCRCSS</p> <p>E3CLDCRCSQ</p>	<p>concealed right hand carrier set, stainless steel</p> <p>concealed right hand carrier set, oil rubbed bronze powdercoat</p>

### LEFT CARRIER SET

PARTS	PARTS ON PANELS	PRODUCT CODE	DESCRIPTION
		<p>E3CLDCLCSS</p> <p>E3CLDCLCSQ</p>	<p>concealed left hand carrier set, stainless steel</p> <p>concealed left hand carrier set, oil rubbed bronze powdercoat</p>

## HARDWARE SELECTION





### INTERMEDIATE CARRIER SET (FOURTH HINGE RECOMMENDED FOR DOORS OVER 2250MM)

PARTS		PARTS ON PANELS	PRODUCT CODE	DESCRIPTION
a)	b)	a)	E3CLDCICSS	concealed intermediate set, stainless steel
			E3CLDCICSQ	concealed intermediate set, oil rubbed bronze powdercoat
			<b>Fourth Hinge</b>	
		b)	E3CLDHNHS	single straight hinge, stainless steel
			E3CLDHNHQ	single straight hinge, oil rubbed bronze powdercoat

a) intermediate carrier set with concealed bottom guide  
 b) fourth hinge recommended for doors over 2250mm

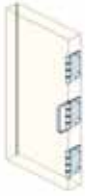

## HARDWARE SELECTION

### STRAIGHT HINGE SET

PARTS		PARTS ON PANELS	PRODUCT CODE	DESCRIPTION
a)	b)	a)	E3CLDHSS	hinge set with handle, stainless steel
			E3CLDHSQ	hinge set with handle, oil rubbed bronze powdercoat
		b)	E3CLDHNHSS	hinge set no handle, stainless steel
			E3CLDHNHSQ	hinge set no handle, oil rubbed bronze powdercoat









a) hinge set with handle for outward opening doors  
 b) hinge set no handle for inward opening doors

### SINGLE HINGE (FOURTH HINGE RECOMMENDED FOR DOORS OVER 2250MM)

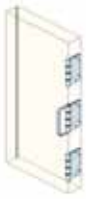
PARTS	PRODUCT CODE	DESCRIPTION
	E3CLDHNHS	single straight hinge, stainless steel
	E3CLDHNHQ	single straight hinge, oil rubbed bronze powdercoat
	E3CLDHS	single straight hinge with handle, stainless steel
	E3CLDHQ	single straight hinge with handle, oil rubbed bronze powdercoat



## HARDWARE SELECTION

### OFFSET HINGE SET

PARTS		PARTS ON PANELS	PRODUCT CODE	DESCRIPTION
a)	b)	a)	E3CLDHHSS	offset hinge set with handle, stainless steel
			E3CLDHHSQ	offset hinge set with handle, oil rubbed bronze powdercoat
			E3CLDHHNHS	offset hinge set no handle, stainless steel
		b)	E3CLDHHNHSQ	offset hinge set no handle, oil rubbed bronze powdercoat
				

a) hinge set with handle for outward opening doors  
 b) hinge set no handle for inward opening doors

### OFFSET SINGLE HINGE (FOURTH HINGE RECOMMENDED FOR DOORS OVER 2250MM)







PARTS	PRODUCT CODE	DESCRIPTION
	E3CLDHHNHS	offset single hinge, stainless steel
	E3CLDHHNHQ	offset single hinge, oil rubbed bronze powdercoat
	E3CLDHHS	offset single hinge with handle, stainless steel
	E3CLDHHQ	offset single hinge with handle, oil rubbed bronze powdercoat

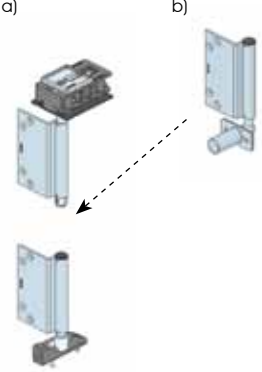

## HARDWARE SELECTION

### PIVOT SET / WALL PIVOT

Wall pivots are mandatory on door panels over 2150mm. Wall pivots are strongly recommended on all door panels in wet or humid climates, exposed locations, inward opening applications and unstable timber doors. A second pivot can be used on door panels over 2250mm to match the additional row of hinges.

PARTS	PARTS ON PANELS	PRODUCT CODE	DESCRIPTION
 <p>a) </p> <p>b) </p>	 <p>a)</p>  <p>b)</p>  <p>c)</p>	<p>E3CLDCPSS</p> <p>E3CLDCPSQ</p> <p>E3CLDWSS</p> <p>E3CLDWPSQ</p>	<p>concealed pivot set, stainless steel</p> <p>concealed pivot set, oil rubbed bronze powdercoat</p> <p>wall pivot set, stainless steel</p> <p>wall pivot set, oil rubbed bronze powdercoat</p>

a) pivot set

b) pivot set and jamb mounted middle wall pivot mandatory on door panels over 2150mm to prevent/control deflection and bowing

c) pivot set and two wall pivots to match hinge pattern on door panels over 2250mm

## SURELOCK™ ADJUSTMENT

Surelock™ is Centor's patented carrier pin locking system which ensures that once door heights are set at the top pivots, intermediate and end carriers, they stay set!

- 1 Components come supplied with a plastic shipping clip installed.
  - 2 Insert a flat-bladed screwdriver into the slot and rotate the pin.
  - 3 When correct adjustment is reached remove the shipping clip.
  - 4 Surelock™ will snap into place when the blade and slot are aligned.
  - 5 To readjust pull the blade down to disengage it from the slot, replace the shipping clip and rotate the pin.
- Remove shipping clip after final installation adjustment.

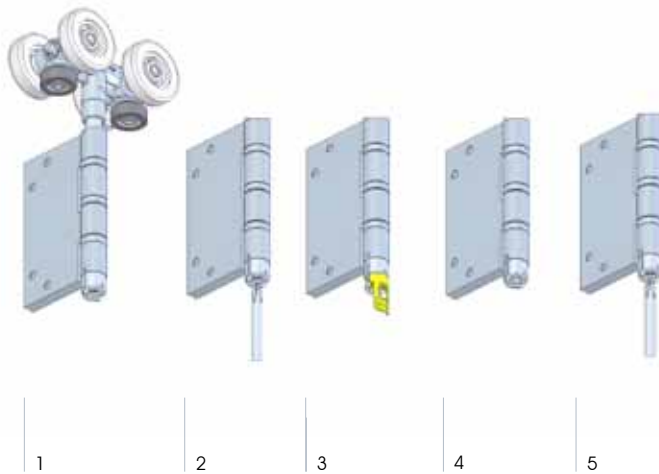

## LATERAL ADJUSTMENT

Centor's track and channel mounted pivot sets are simply and easily adjusted so doors can be set parallel to the head and sill, and correctly positioned for locks and latches.

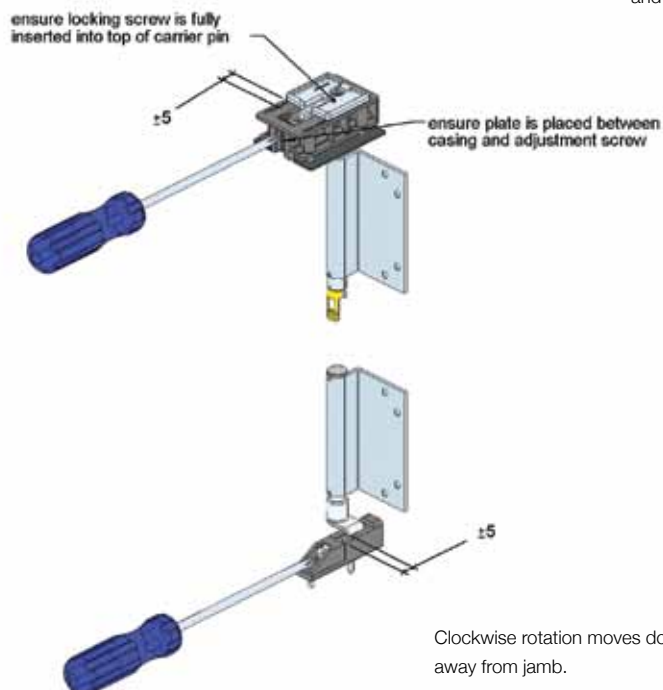

## E2

E2 is a medium bifolding door hardware system for panels to 40 Kg. E2 is suitable for a range of residential and light commercial applications which do not require the extra capacity of the medium-heavy E3 or the substantial E4 heavy-duty door system. Easily installed E2 hardware can be teamed with standard door panels in timber, aluminium, PVC or fibreglass.

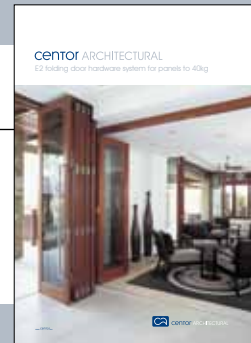

## E3

Centor E3 is a medium-heavy bifolding door hardware system for door panels to 100 Kg. E3 is suitable for a range of applications from stylish private residences to the most ambitious store front, restaurant or commercial project; anywhere the ability to flexibly manage space to suit lifestyle or business is required. Easily installed E3 hardware can be teamed with standard door panels in timber, aluminium, PVC or fibreglass.



## E4

Centor's most generously proportioned solution for creating seamless transitions between indoor and outdoor spaces, E4 is heavy-duty bifolding door hardware for panels to 120 Kg. E4 is suitable for openings in larger residential and commercial applications. Taller, wider door panels, expanses of framed glass; E4 provides the flexibility to manage space for lifestyle or business – on a grand scale.

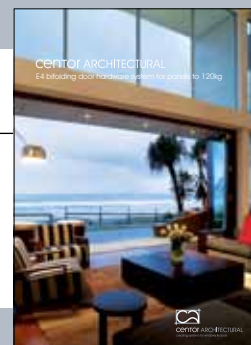

## DROPBOLTS

Centor's stylish keyed and non-keyed, flush-mounting dropbolts are the ideal solution for securing or fastening in place closed folding or sliding windows and doors. Produced to Centor's exacting standards for functionality, aesthetics and longevity, seven distinctive dropbolt ranges are available in lengths, styles and finishes to suit virtually any application.

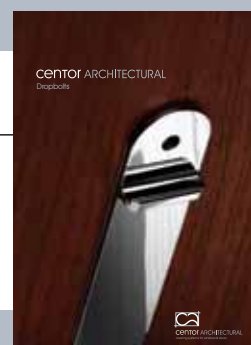

## S1 SCREEN

Centor's S1 Screen is a superbly effective solution for any architectural opening up to 3 meters high and 7.4 meters wide. Used alone or in pairs, the system allows for a choice of opening positions and the frames are available in custom colors and real wood veneers. Centor's innovative Load Balancing and Tight Technologies are built in each screen assuring mesh tension and effortless fingertip control.

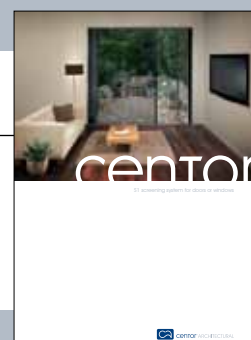



215-300-090-001

Centor Europe Ltd

610 Solar Park  
Highlands Road  
Solihull, B90 4SH, UK  
telephone +44 (0)121 701 2500  
facsimile +44 (0)121 701 2515  
mail@centor.eu  
www.centor.eu

centor®